

Wire-free Switch (2 Gang)

Model Nos LW221 & LW206

Instruction Manual



Connect Series

www.lightwaverf.house

EC DECLARATION OF CONFORMITY

Responsible Authority:

LightwaveRF PLC,
Innovation Campus Birmingham
Faraday Wharf
Holt Street
Birmingham
B7 4BB

Tel: +44 (0)121 250 3625
Email: enquiries@lightwaverf.com

Model Number(s):

JSJSLW221 & 206

Description:

Wire-free Switch

Directives this equipment

Complies with:

2006/95/EC The Low Voltage Directive N/A
2004/108/EEC The Electromagnetic Compatibility Directive
1999/5/EC R&TTE Directive
93/68/EEC CE Marking Directive

Standards Applied in order to verify compliance

Safety: BS EN 60730-1: 2011

Health:

R&TTE: EN 301 489-1 V1.9.2: (2011-09), EN 301 489-3 V1.4.1: (2002-08)
EN 300 220-1 V2.1.1: 2006, EN 300 220-2 V2.1.2: 2007
EMC: EN 301 489-1 V1.9.2: (2011-09), EN 301 489-3 V1.4.1: (2002-08),
EN 55022: 2010, EN 61000-3-2: 2006 +A1: 2009 +A2: 2009 Class A,
EN 61000-3-3: 2008, EN61000-4-2: 2009,
EN 61000-4-3: 2006 +A1: 2008 +A2: 2010, EN 61000-4-4: 2012,
EN 61000-4-5: 2006, EN 61000-4-6: 2009, EN 61000-4-11: 2004

For and on behalf of LightwaveRF PLC

Name

J Shermer

Position

Managing Director



How do I get started?

Please refer to the following installation and setup instructions that will guide you through the installation and setup process.



What do I need?

The Wire-free Switch can be positioned anywhere. To install it, you will need simply to apply the adhesive strips provided and attach the switch to a wall or flat surface. You can also mount the switch to a standard back-box or flat surface using suitable screws (not included).

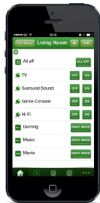

Help video & further guidance

For additional guidance, and to watch a video that will help guide you through the installation process, please visit the support section on www.lightwaverf.com



Overview

On button.
Tap to turn on
linked devices or
hold to raise dim
level.

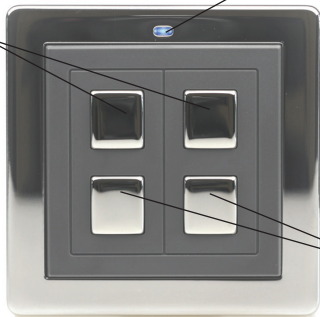

Blue indicator LED.
When illuminated, the
switch is sending a
command.

Off button. Tap to
turn off linked
devices or hold to
lower dim level.

IMPORTANT: Please retain these instructions for guidance on how to link Remote Handsets and other LightwaveRF controllers. For additional guidance please visit www.lightwaverf.com

Installation



NOTE: It is important to install this product in accordance with the following instructions. Failure to do so may void your warranty.

LightwaveRF is fully legal to install in your own home. However, if in doubt, always consult a qualified electrician.

Mounting to the wall

The following installation instructions illustrate how to remove the Wire-free Switch faceplate and surround in order to screw the unit to a back-box. The unit does not have to be screw mounted and may instead be attached using the adhesive strips provided. These should be attached to the rear of the surround rather than the centre of the switch so that the centre can easily be removed to gain access to the battery compartment.

- 1.** Gently remove the faceplate by inserting a screwdriver into the slot on the base and lifting away from the unit as shown.

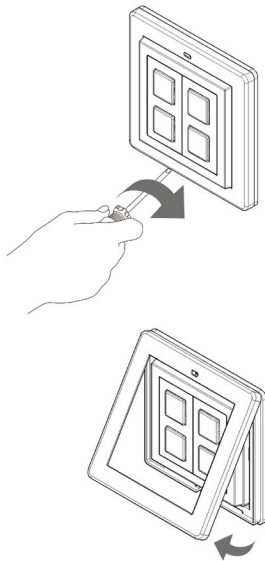

2. Insert the screwdriver under the tab situated at the bottom of the switch as show. Gently remove the central section from the surround.

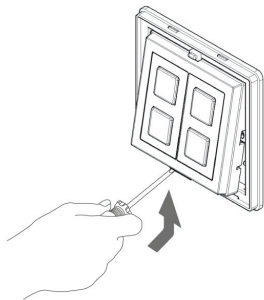

3. Insert suitable screws into the mounting holes and screw to the back box. Alternatively, place the adhesive strips along the rear sides of the surround and attach to the wall.

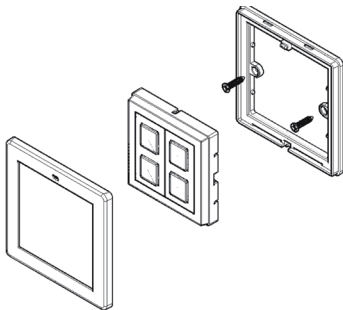

4. Replace the switch centre unit and clip the faceplate back into place. Make sure that the faceplate hooks in from the top as shown. A sharp click will indicate that the plate has been successfully replaced.

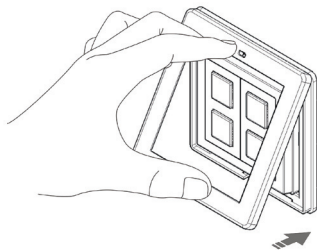

Changing the Battery

The battery compartment is accessed from the rear of the switch. If the switch is wall mounted, the compartment can be accessed by removing the central section as previously described. A CR2032 standard coin cell battery is required to power the unit.

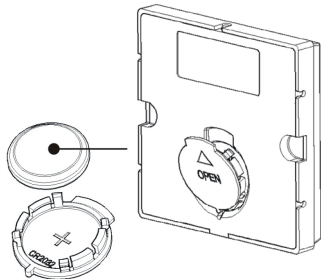

Operation & Setup

Manual operation

- Tap either 'on' button to switch on linked LightwaveRF devices (Blue LED indicator will illuminate). Hold the button to raise the dim level of dimmable devices.
- Tap either 'off' button to switch off linked LightwaveRF devices (Blue LED indicator will illuminate). Hold the button to lower the dim level of dimmable devices.

Linking the switch to a LightwaveRF device

1. Place the LightwaveRF device that you wish to control in 'linking' mode. For information on how to do this please refer to the instruction manual for that specific LightwaveRF device.



2. Whilst the LightwaveRF device is in linking mode, tap a button on the left or right hand gang of the Wire-free Switch. The indicator light on the target device will flash to confirm that that gang of the switch is now linked. This process can be repeated to control multiple LightwaveRF devices from one switch.



Unlinking the switch

1. Place the LightwaveRF device that you wish to remove in 'linking mode'. For information on how to do this please refer to the instruction manual for that specific LightwaveRF device.



2. Whilst the LightwaveRF device is in linking mode, tap a button on the gang of the Wire-free Switch that needs to be unlinked. The LED light on the target device will flash to confirm that the switch and device are unlinked.





1. (Easy): Group standby / dimming control

Required: Wire-free Switch / plug-in sockets

A Wire-free Switch can be used to control any number of LightwaveRF sockets, dimmers, plug-in sockets and Plug-in Dimmers. This means you can now dim all of your lounge lamps and main light from one attractive, wall mounted Switch! You can even turn off any 'standby' devices (TV, Freeview box, DVD player, blue-Ray player etc.) that can be plugged into any LightwaveRF socket from one convenient place. This can also be more practical than a remote control as the switch will never go missing!





2. (Intermediate): Bedside light-switches

Required: Wire-free Switches, dimmer, plug-in sockets

Installing extra light-switches in a room can be messy, time consuming and costly due to the cabling involved. However, if you swap your existing main light-switch for a LightwaveRF one, adding extra switches is easy because you can use a Wire-free Switch to avoid any extra cabling. For instance, a bedside 2-gang wire-free can wirelessly communicate with the main light and with a bedside lamp plugged into a LightwaveRF plug-in socket. Best of all, these switches can be attached anywhere - even to the bed-head itself!



Problem: *The switch won't transmit and the LED does not light up.*

Solution: Change the switch battery. A strong battery signal is indicated by the LED light on the switch illuminating and remaining lit for 1-2 seconds after tapping the 'on' button. A low battery is indicated if the LED light turns off immediately, or does not illuminate at all.

Problem: *The Wire-free Switch will not link to/operate the target device.*

Solution: Check the switch battery strength: if the battery strength is low, it will not produce enough power to drive the RF radio signal. Tap the 'on' button on the Switch to transmit a signal. A strong battery signal is indicated by the LED light on the Switch remaining lit for 1-2 seconds after releasing the button. A low battery is indicated if the LED light turns off immediately. If this happens, please replace the battery.

Problem: *The Wire-free Switch will not work consistently.*

Solution: The Wire-free Switch may be encountering interference or may be at the edge of its reliable range of operation. First, ensure that there are no large pieces of metal, very thick walls or bodies of water in the path of the transmission. If the problem persists, try moving the switch closer to the Socket, or consider using a LightwaveRF Signal Booster to extend the range by relaying the signal between the switch and target device.

Q. *How long does the Wire-free Switch battery last?*

A. This depends on use, but 2 years is a reliable average.

Q. *How do I know if the battery needs changing?*

A. A strong battery signal is indicated by the indicator LED illuminating and remaining lit for 1-2 seconds after tapping the 'on' button. A low battery is indicated if the LED light turns off immediately, or does not illuminate at all.

Q. *Can I control multiple devices with one Wire-free Switch?*

A. Yes you can link as many LightwaveRF receiver devices (such as dimmers and sockets) as you wish to the same Wire-free Switch.

Q. *How many devices can I have on the LightwaveRF system?*

A. Each receiver device (such as a dimmer or socket) has 6 memory slots for up to 6 controllers (such as a Wire-free Switch). Note: The Lightwave Link allows a number of different smartphones to control the socket independently, however it only uses one memory slot.

Q. *How do I know that the switch will fit my back-box?*

A. The Wire-free Switch will screw into any standard single back-box.

Q. *Is it legal for me to install LightwaveRF devices myself?*

A. Yes, Lightwave products are fully legal to install in your own home.

Specification

RF frequency: 433.92 MHz

Output rating: 3V

Mounting: Standard single back-box or sticky pads

Dimensions: Width 88mm, Height 88mm, Depth 14mm

Warranty: 2 year standard warranty



Lightw^wave^{RF}

MEGAMAN[®]

2 Quadrant Park
Mundells
Welwyn Garden City
Herts
AL7 1FS
01707 386035

www.lightwaverf.house